

SURFgroups

ViDe Spring Member meeting 2007 – Erik Dobbelsteijn, SURFnet – erik.dobbelsteijn@surfnet.nl



Offering RTC to the masses



Developments

- SURFnet customers: Innovation is good, focus on consolidation
- User survey: interesting results
- What to do with existing emerging systems (Skype, MSN etc)?

Solutions:

- Provide easy to use systems
- Connect to installed base
- Use software
- Provide Lego[©] bricks
- Integrate

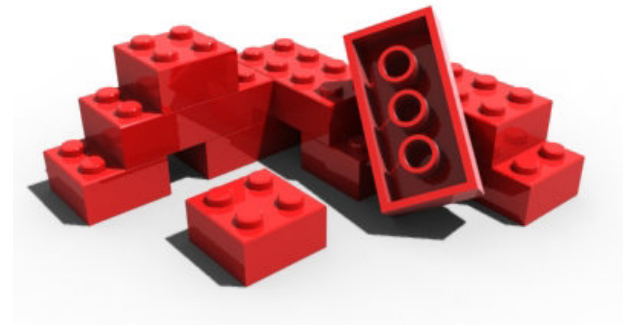



Choices...



H.323

SIP



Breeze



EVO

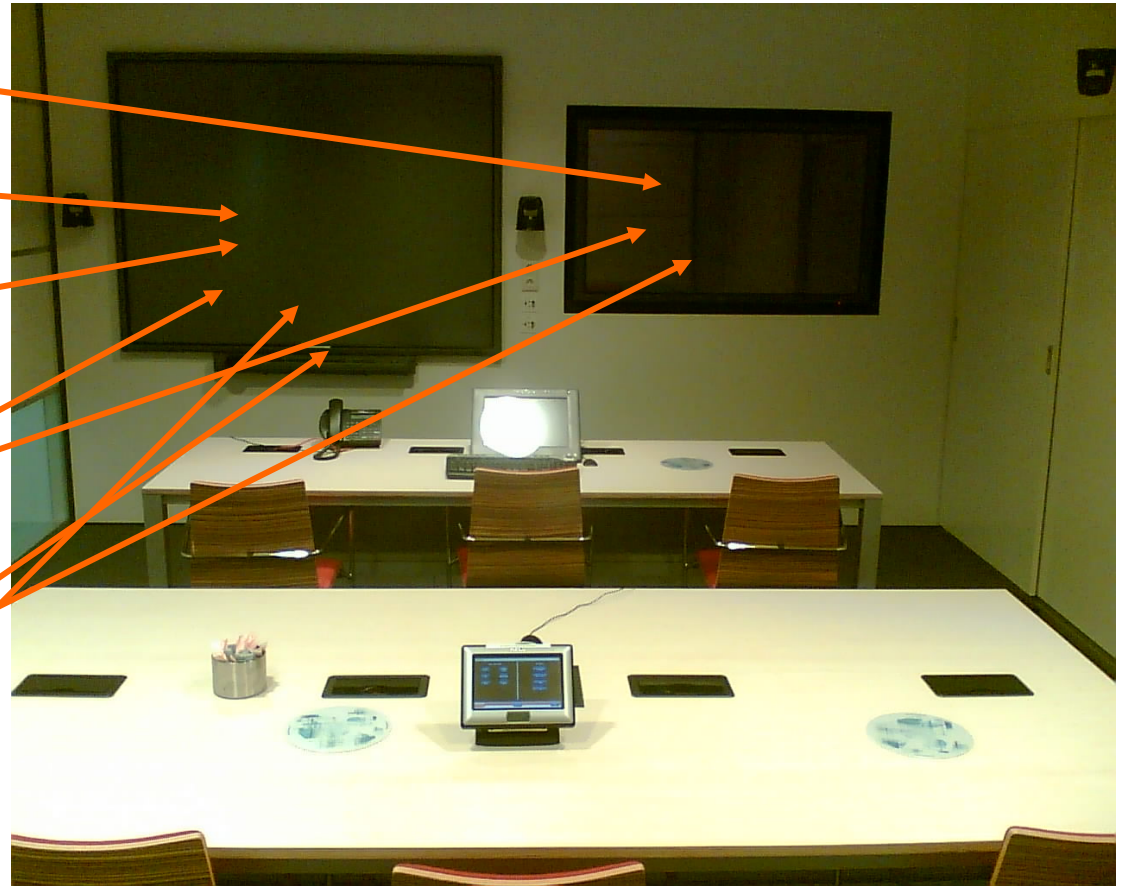

Incidentally: DVTS, ISABEL, Click to Meet 



...and resulting technology

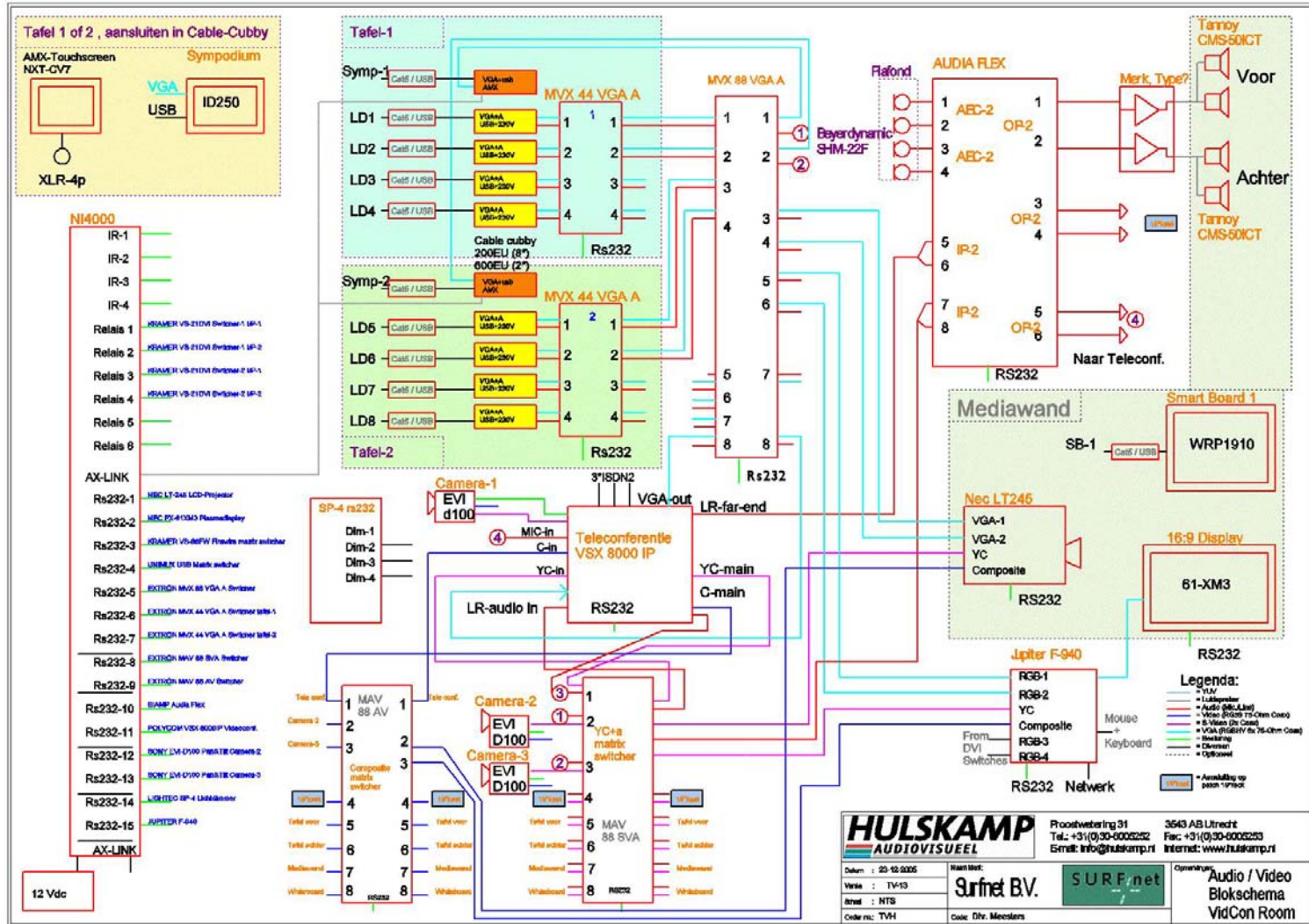



Hardware vs Webbased Conferencing (t.b.d.)



Hardware based

- H.323, SIP
- Firewall ☹️
- Installation
- € € € €
- Features ☹️
- Quality 😊

Webbased

- Proprietary
- Network no-brainer
- Zero-install
- Cheapo
- Feature rich
- Quality ☹️ (improving)

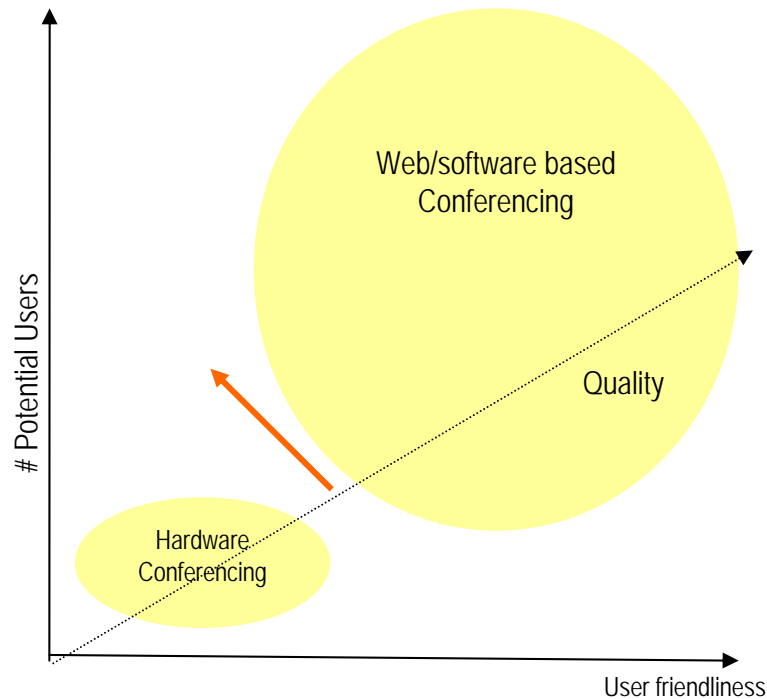



SURFgroepen (‘SURFgroups’)



Document Sharing

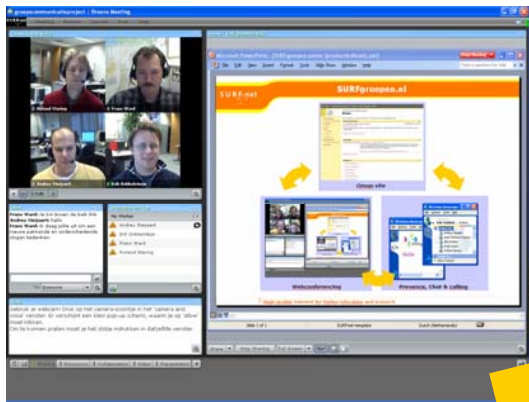

Webconferencing

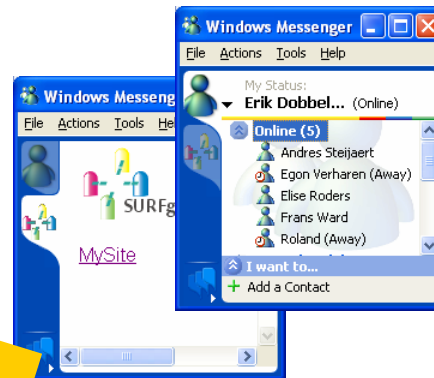

Instant Messaging

Combines:

- Documentsharing
- Chat/IM
- Webconferencing

All employees and students connected to SURFnet can get an account and create groups.

Everything they need is provided to support a project team, a class, course or other educational collaborations, especially over the borders of one institution



SURFgroepen in 2006



- Integration, integration, integration (remember?)
- Steady growth without promotion
- 'invite webpart' -> exponential growth
- 'Lego blocks' are working!
- Need for specialized templates



Sharepoint 2007



- Sharepoint 2003 -> 2007
- Not just teamsites, also CMS
- A lot of new 'Lego blocks':
 - Blogs
 - Wiki
 - RSS
 - mailinglists
- Improved account management & autorisation
- 'Variations' for multilingual content and support for mobile devices



Sharepoint 2007



Home - Migratie Sharepoint 2007 - Windows Internet Explorer

http://intra.2at.net/development/surfgroepen/sharepoint2007/default.aspx

File Edit View Favorites Tools Help

2AT Intranet

Welcome Erik Dobbelseijm | My Site | My Links |

Migratie Sharepoint 2007

All Sites Advanced Search

2AT Intranet Engineering

View All Site Content

Documents

- Shared Documents

Lists

- Calendar
- Tasks

Discussions

- Team Discussion

Sites

People and Groups

- Recycle Bin

2AT Intranet > Development > SURFGroepen > Migratie Sharepoint 2007

Teamsite voor samenwerken aan migratie naar Sharepoint 2007

Announcements

Herindeling/opschoning shared folder 22-3-2007 12:21
by J.W.A.M. Vugs
Voor een beter overzicht (hoop ik), zijn de documenten enigszins herverdeeld en opgeschoond. Niet relevante documenten zijn verwijderd.

Planningen ge-update 2-3-2007 16:35
by Pieter-Jan van Herel
Nav wijzigingen in scope is de planning ge-update. Zie de projectbestanden in de planning map. Oja, PJ beschikt nu ook over Project 2007 :-)

Herindeling bestanden 23-2-2007 13:09
by B.U. Nideröst
Om Shared Documents bij het groeiende aantal bestanden manageable te houden heb ik twee folders aangemaakt:

- Planningen - Voor alle planningsdocumenten
- Impactanalyse - Voor de verschillende documenten die bij de impactanalyse horen.

Add new announcement

Calendar

There are currently no upcoming events. To add a new event, click "Add new event" below.

Add new event



Links

There are currently no favorite links to display. To add a new link, click "Add new link" below.

Add new link

Done Internet 100%



Migrating to 2007



- Big Bang scenario
- New hardware
- DAS -> SAN
- Migrate code
 - User registration
 - User & Group invitation
 - User provisioning to all applications
 - Reporting
 - All of this transaction based
- Breeze will be migrated to Adobe Connect
- MS ISA server will offload SSL for Connect media
- SSO within the platform
- Database freeze & migration (1 day out)



SSL



- Already for Sharepoint, Breeze log on, LCS
- Breeze will have to be migrated to Adobe Connect
- MS ISA server will offload SSL for Connect media



Single Sign On



- A-Select Integration Component developed
- SURFnet Federation is ready to go (A-Select based)
- SWITCH 'eConfportal' (shibboleth based) connected to the Federation
- Old architecture: each application should have an IC
- New proxy based architecture: connection to the Federation at a central point, SAML based
- New IC needed at the proxy
- Non-web based applications still a problem: webdav, SIP
- SIP: first static peerings established



SSO: WS-fed

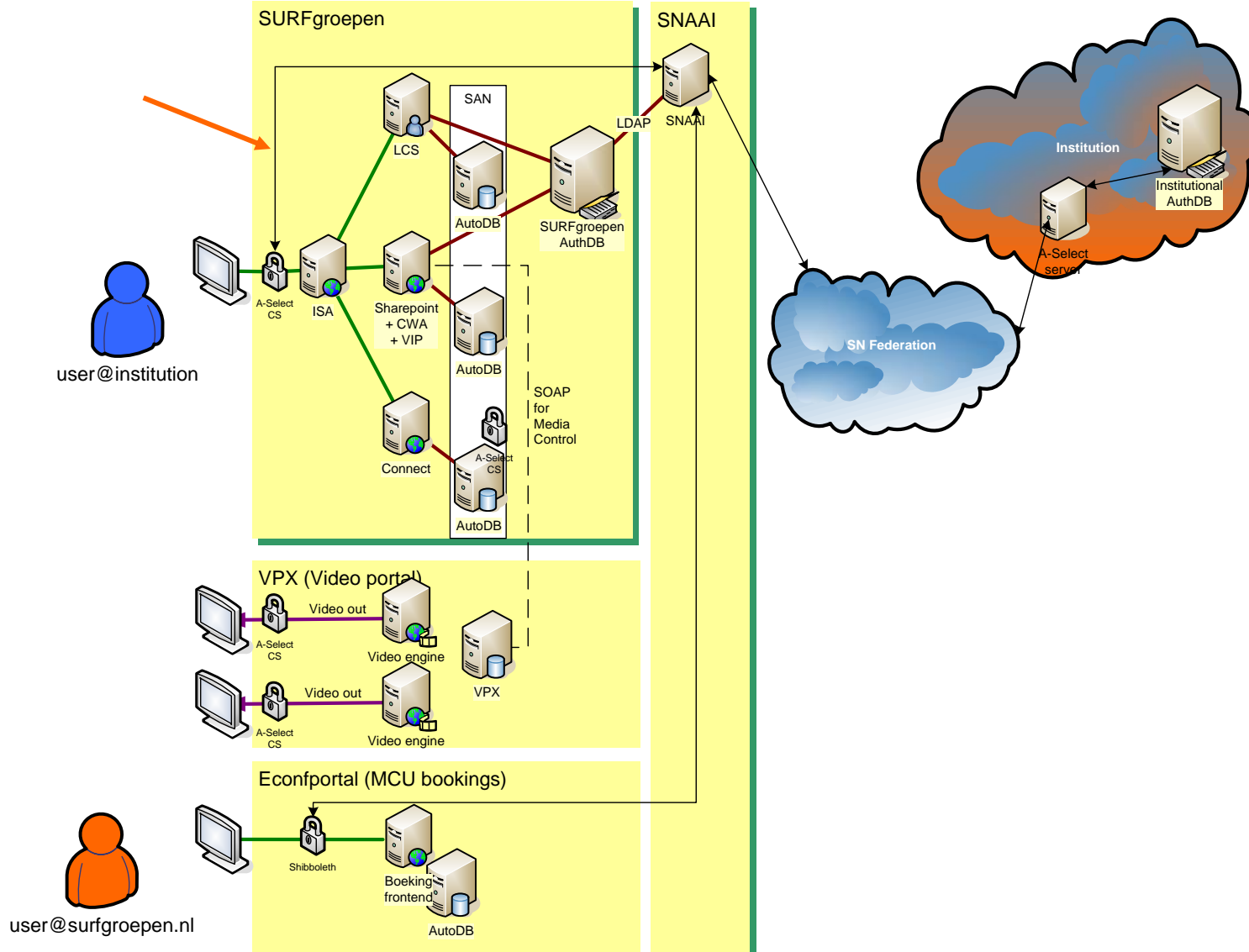



SSO: SURFgroepen as a VHO



SURFnet - Diensten - Windows Internet Explorer

https://conferencing.surfnet.nl/www/news/

File Edit View Favorites Tools Help

SURFnet - Diensten

SURFnet Hoogwaardig internet voor hoger onderwijs en onderzoek

Login

- EoA Boekingen
- Boek een sessie
- Gebruikersbeheer
- Informatie

Nieuws

- Helpdesk
- Sessie Helpdesk

Expert op Afstand - boekingsysteem

Met het boekingsysteem kunnen webconferencing en H.323 videoconferencing sessies geboekt worden. Het systeem zal tot januari 2007 op experimentele basis ingezet worden voor het Expert op Afstand project.

Quick Links

- ▶ [Boek een hardware videoconferencing sessie](#)

SURFnet bv, Radboudkwartier 273, Postbus 19035, 3501 DA Utrecht. T +31 302 305 305, F +31 302 305 329, Admin@SURFnet.nl
©SURFnet redactie@SURFkit.nl

Trusted sites 100%



SSO: SURFgroepen as a VHO



Authentication Required | A-Select Server 1.5 - SURFnet Authenticatie Autorisatie Infrastructuur - Windows Internet Exp...

https://snaai.surfnet.nl/aselectserver/server?request=login1&rid=631574E9E0E2C

File Edit View Favorites Tools Help

Authentication Required | A-Select Server 1.5 - SURF...

A-SELECT
SURFnet Authenticatie Autorisatie Infrastructuur
[Nederlands](#) | [English](#)

A-Select Authenticatie

Toegang tot de toepassing *Conferencing MCU Reservering* vereist authenticatie.

Voer je 'SURFnet Beheer inlognaam' of je 'SURFgroepen inlognaam' (inclusief @surfgroepen.nl) in en druk op de "Login" knop om door te gaan.

Inlognaam:

SURFnet Authenticatie Autorisatie Infrastructuur is *niet* mijn Identity Provider.
Gebruik de [SURF Federatie](#) om in te loggen via mijn onderwijsinstelling.

Dienst: Conferencing MCU Reservering
Vragen: conferencing@surfnet.nl

A-Select Server 1.5 - Javascript en cookies vereist

Trusted sites 100%



SSO: SURFgroepen as a VHO



Internet Explorer window showing the SURFnet reservation system interface. The URL is https://conferencing.surfnet.nl/www-aa1/mcu_reservation/.

SURF.net | Hoogwaardig internet voor hoger onderwijs en onderzoek

EoA Boekingen

- Boek een sessie
- Mijn sessies
- Nieuwe reservering →

Gebruikersbeheer

Informatie

Nieuws

Helpdesk

Sessie Helpdesk

1 Datum/Duur 2 Deelnemers 3 Geavanceerde Instellingen 4 Bevestiging

Datum/Duur

Voer hier de datum, tijd en duur van uw videoconferentie in.

Event name

Vide2007 demo

Datum

Maart, 2007							
(vandaag)							
wk	Ma	Di	Wo	Do	Vr	Za	Zo
9	26	27	28	1	2	3	4
10	5	6	7	8	9	10	11
11	12	13	14	15	16	17	18
12	19	20	21	22	23	24	25
13	26	27	28	29	30	31	1
14	2	3	4	5	6	7	8

Selecteer datum

Bestaande reserveringen

2007-03-25

Geen reserveringen

Starttijd (UTC+2) 22 h 15 min Start onmiddelijk

Duur 01 h 00 min

>> verder

SURFnet bv, Radboudkwartier 273, Postbus 19035, 3501 DA Utrecht. T +31 302 305 305, F +31 302 305 329, Admin@SURFnet.nl ©SURFnet redactie@SURFkit.nl



Use cases



- Both hardware based as well as software based conferencing
- Scholarly Workbench investigation, probably resulting in templates, web parts and workflows for researchers
- New home for existing 'Theme sites': mix of CMS/wiki for existing communities



Webbased Communicator



The screenshot shows a web browser window displaying a SharePoint site for 'Groepscommunicatieproject'. The browser address bar shows the URL: <https://www.surfgroepen.nl/sites/groepscommunicatieproject/default.aspx>. The site content includes a navigation menu on the left with options like 'Documents', 'Pictures', 'Lists', 'Discussions', and 'Surveys'. The main content area features an 'Announcements' section with several entries, including one about 'Info op sharepoint@2at' and another about 'SURFnet contactgegevens'. Below the announcements is a 'Page Viewer Web Part' for 'mantis', a bug tracking system. The user is logged in as 'erik' (Erik Dobbelsteijn - administrator) on 03-25-2007 22:09 CEST. At the bottom, there are summary statistics for 'Assigned to Me (Unresolved)' and 'Unassigned' items.

Overlaid on the right side of the browser window is a contact list window from 'https://cwa.surfgroepen.nl/...'. The window title is 'Connect Contacts Actions Help'. It shows the user 'Erik Dobbelsteijn' is 'Online' and 'about to go...'. There is a search bar with the text 'Enter display name or e-mail address' and a 'Find' button. Below the search bar is a list of 'Other Contacts: 3/23' with the following entries:

Name	Status
Egon Verharen	Away
Frans Ward	Away
Peter Hinrich	Away
Andres Steijaert	Offline
Beat Nideröst	Offline
Bert Andree	Offline
Boudewijn van der ...	Offline
Brunolf Kleve	Offline
Calluna Tenge	Offline
Elise Roders	Offline

At the bottom of the contact list window, there is a prompt: 'Click a contact to view more information.'



Book an Expert



Home - Expert op afstand - Windows Internet Explorer

https://www.surfgroepen.nl/sites/expertopafstand/default.aspx

File Edit View Favorites Tools Help

SURFnet - Diensten Home - Expert op afstand

Home Documents and Lists Create Site Settings Help Up to SURFGroepen

Expert op afstand Home Modify My Page

Projectsite voor het expert op afstand project

Announcements

Functioneel Ontwerp opgeleverd 13-4-2006 15:51
by Roland
Versie 1.0 van het functioneel ontwerp is opgeleverd.
Voor meer informatie zie:
<https://www.surfgroepen.nl/sites/expertopafstand/functioneelontwerp/>

Projectplan goedgekeurd door programmamanagement 13-4-2006 15:28
by Roland
Versie 1.1 is officieel goedgekeurd door het programmamanagement.

▣ Add new announcement

1 Datum/Duur 2 Deelnemers 3 Geavanceerde Instellingen 4 Bevestiging

Datum/Duur

Voer hier de datum, tijd en duur van uw videoconferentie in.

Event name
Vide2007 demo

Datum

Maart, 2007						
(vandaag)						
wk	Ma	Di	Wo	Do	Vr	Za Zo
9	26	27	28	1	2	3 4
10	5	6	7	8	9	10 11
11	12	13	14	15	16	17 18
12	19	20	21	22	23	24 25
13	26	27	28	29	30	31 1
14	2	3	4	5	6	7 8

Selecteer datum

Bestaande reserveringen

2007-03-25
Geen reserveringen

Starttijd (UTC+2)
22 h 15 min Start onmiddelijk

Duur
01 h 00 min

>> verder

foo+ioii
expert op afstand

macromedia BREEZE
naar breeze

EoA subsites

- Functioneel ontwerp document
- Boekingsysteem/scheduling software
- Expert op afstand groep voor eindgebruikers

▣ Add new link

Soortgelijke initiatieven

- Soortgelijke initiatief Amerika
- JANET/Ukerna initiatief voor videoconferencing met scholen
- Overzicht van K12 videoconferencing databases
- Jet Net website - Jongeren en techniek

▣ Add new link

Internationale events

- Science Live!
- Megaconference Junior!

▣ Add new link

Members

Online
None of the members are online.

Not Online

- Danny van Gelder
- Erik Dobbelsteijn

Trusted sites 100%



Telepresence



Live connection between SURFnet Utrecht and a Hotel in High Definition quality 20



Remote diagnostics



Live connection between Radboud University Hospital and Lowlands - 2006